

BOSS PS-3

DIGITAL PITCH SHIFTER / DELAY

SERVICE NOTES

First Edition

EXPLODED VIEW/分解図

SPECIFICATIONS/仕様

- Signal processing: A/D Conversion; 16 bit lineal,
128 times oversampling, $\Delta \Sigma$ modulation, AF method
D/A Conversion; 16 bit linear
- Sampling Frequency: 32kHz
- Nominal Input Level: -20dBm
- Input Impedance: 1M Ω
- Nominal Output Level: -20dBm
- Output Impedance: 1k Ω
- Recommended Load Impedance: 10k Ω or greater
- Dynamic Range: 110dBm or greater(Direct)
95dBm or greater(Effect)
* 0dBm = 0.775 Vrms
- Controls: Pedal Switch, Mode Switch, Balance knob, Control Knob x 2
- Indicator: Check Indicator(serves also as battery check indicator)
- Connectors: Input Jack, Output Jacks A(MONO)/B, Expression Jack,
AC Adaptor Jack(9V DC)
- Power Supply: 9V DC:Dry Battery(6AM6/9V),
AC Adaptor(PSA-Series:Optional)
- Current Draw: 70mA(9V DC)
- Dimensions: 70(W)x125(D)x55(H) mm
2-3/4(W)x4-15/16(D)x2-3/16(H) inches
- Weight: 420g / 15oz (including battery)
- Accessories: Owner's Manual(English) PNo.00451701
Owner's Manual(Japanese) PNo.00451690
MODE Label PNo.00349934
Battery 006P 9V alkaline PNo.12569173
- Options: AC Adaptor;PSA-100, PSA-120, PSA-230, PSA-240,
Expression Pedal FV-300L with PCS-33(Roland),
Expression Pedal EV-5(Roland), Foot Switch FS-5U/5

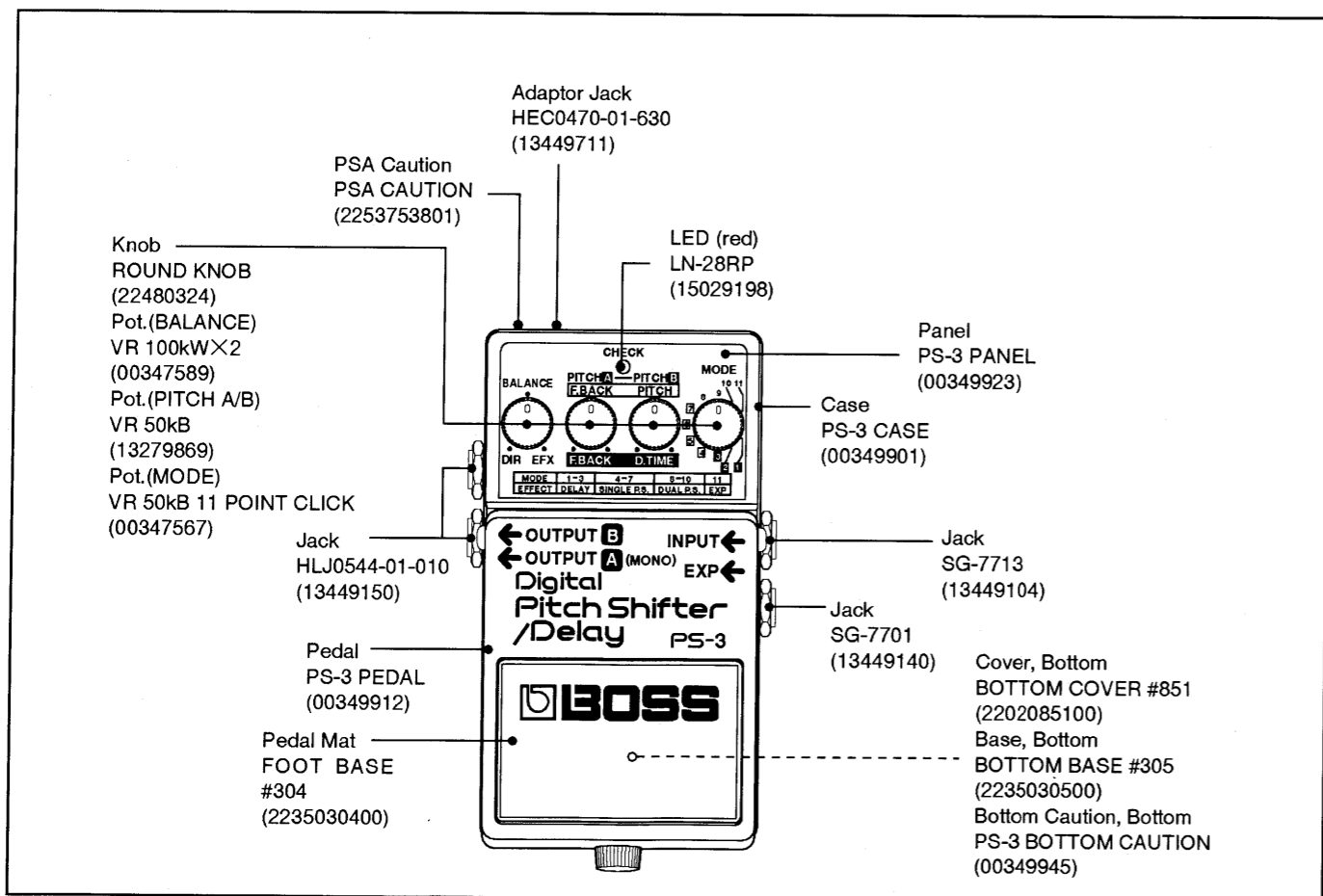
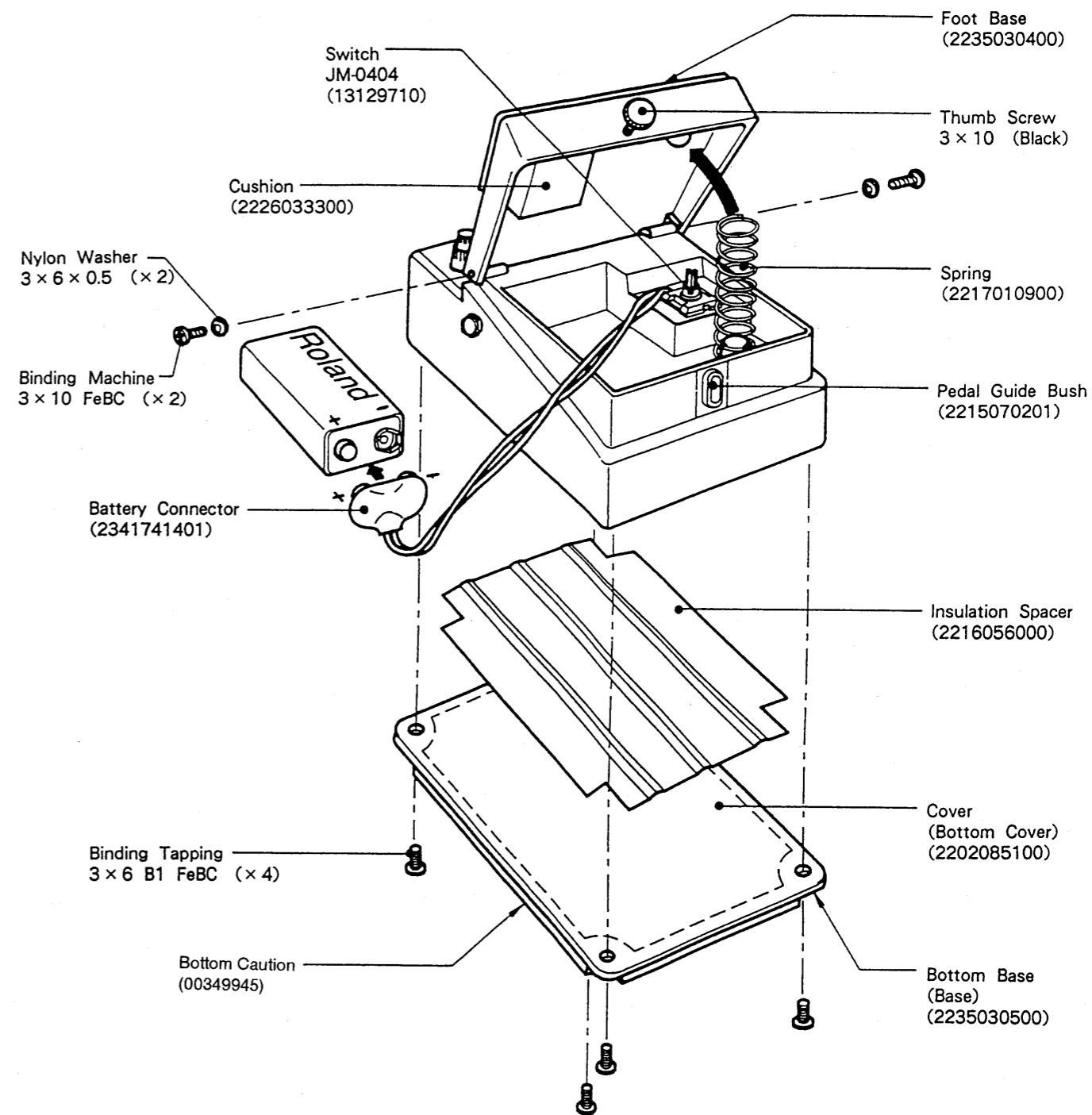

PARTS LIST/パーツリスト

SAFETY PRECAUTIONS:
 The parts marked Δ have safety-related characteristics. Use only listed parts for replacement.
 安全上の注意:
 Δが付いている部品は、安全上特別な規格でつくられたものです。交換の際は、指定された部品番号以外の部品は使わないようにして下さい。

CONSIDERATIONS ON PARTS ORDERING
 When ordering any parts listed in the parts list, please specify the following items in the order sheet.

Ex.	QTY	PART NUMBER	DESCRIPTION	MODEL NUMBER
10	22575241		Sharp key	C-20/50
15	2247017300		Knob (orange)	DAC-15D

 Failure to completely fill the above items with correct number and description will result in delayed or even undelivered replacement.
パーツ発注に関するお願い
 オーダーシートには、必ず下記の4項目は正確に記入して下さい。(例外は除く)

必要数	パーツ番号	品名	使用機種
例) 10	22575241	Sharp key	C-20/50
15	2247017300	Knob (orange)	DAC-15D

 もし記入漏れ、誤記等がある場合、必要部品が発送できなかったり、大幅な遅れの原因になります。御協力をお願いします。

CASING/ケース

00349901	PS-3 CASE
00349912	PS-3 PEDAL
2202085100	BOTTOM COVER #851
2235030400	FOOT BASE #304
2235030500	BOTTOM BASE #305
00349923	PS-3 PANEL

KNOB/ツマミ

22480324	ROUND KNOB
----------	------------

SWITCH/スイッチ

13129710	JM-0404
----------	---------

JACK, SOCKET/ジャック、ソケット

13449104	SG-7713	INPUT
13449140	SG-7701	EXP
13449150	HLJ0544-01-010	OUTPUT
13449711	HEC0470-01-630	AC Adapter

PCB ASSY/基板完成品

70343134	PS-3 BOARD (pcb 00348112)
NOTE	Replacement PS-3 Board Ass'y includes VR Board Ass'y.
注	補修用PS-3 Boardは、VR Boardを含みます。
70347489	LED BOARD (pcb 2291049600)
NOTE	LED Board (#70347489) for PS-3 is compatible with the following LED Boards for other models such as CE-5, MT-2 and OS-2.
注	PS-3用LED BOARDは他機種(CE-5, MT-2, OS-2等)用LED BOARDと互換性があります。 7528055000 CE-5 7527554000 MT-2 7526954000 OS-2 etc
7524452000	CH-1 JACK BOARD (pcb 2292768700)
NOTE	JACK Board (#7524452000) for PS-3 is compatible with the following JACK Boards for other models such as CE-5 and CH-1.
注	PS-3用JACK BOARDは他機種(CE-5, CE-1)用JACK BOARDと互換性があります。 7528054000 CE-5 7524452000 CH-1

IC

00452190	PS-3 CPU M37470M2-244SP	CPU(MASK)
15199240	TA78L05S	+5V Voltage Regulator
00346723	TC25SC080AU-104	MR Chip(DSP)
00347323	M5M44256BJ-8	DRAM
00347145	LC8390M	A/D
00347156	μ PD6379GR	D/A
15189261	M5218AFP-600E	CEA OP AMP
00346445	NJM2100M	OP AMP
00347189	M51951AML	RESET IC

TRANSISTOR/トランジスタ

15129185	2SC2458GR	
15329103T0	2SK880GR-TE85R	
15309110	2SA1312GR-TE85R	
15329521	RN1307-TE85R	Digital Tr.

DIODE/ダイオード

15029198	LN-28RP	LED
15039118	S5688G	
15019526	ZDi RD5.6EB3	
15339121	1SS-302-TE85R	
15339119T0	1SS352-TPH3	

POTENTIOMETER/ボリューム

00347589	VR 100KW×2	BALANCE
13279869	VR 50KB	
00347567	VR 50KB 11 POINT CLICK	MODE
00347256	TRIMER RH03A3AJ3X 2.2K	

INDUCTOR, COIL, FILTER/インダクター、コイル、フィルター

13529145	DSS306-55FZ103N	EMI FILTER
----------	-----------------	------------

CRYSTAL, RESONATOR/クリスタル、発振子

15299159	CST4.00MGW	
15299141	MA-506 24.576MHz	

WIRING, CABLE/ワイヤリング、ケーブル

00347389	FLAT CABLE 5P	
----------	---------------	--

BATTERY/電池

12569173	BATTERY 006P 9V ALKALINE	6AM6
----------	--------------------------	------

SCREW/ネジ類

40016512	INSULOK TIE T-18S	
40125134	NYLON WASHER 3x6x0.5	
40125101	THUMB SCREW (Fe BLACK)	
40010901	BINDING TAPPING 3x6 B1 FeBC	COVER
40010834	BINDING TAPPING 3x6 B1 FeCm	LED
40010267	BINDING MACHINE 3x10 FeBC	PEDAL
40123545	JACK NUT 9x12x2 FeNi	
2213070900	JACK SPACER AL	
40011923	INTERNAL TOOTH WASHER 9.1x13	
40016467	JACK WASHER 9.2x14x0.5 FeNi	
*****	THICK JACK WASHER 9.2x14x1.6 AL (=>RTC)	

MISCELLANEOUS/その他

2215070201	PEDAL GUIDE BUSH #702	
2341741401	BATTERY CONNECTOR	
2226033300	CUSHION #333	
2217010900	COIL SPRING #109	
00349945	PS-3 BOTTOM CAUTION	
00451723	PS-3 INSULATION SPACER	
40013245	POLYCA PIPE 3x6x6	
2225025700	RV-2 EARTH LUG	
2253753801	PSA CAUTION	
00451689	PS-3 INDIVIDUAL BOX / 化粧箱	

ACCESSORIES/標準付属品

00451690	Owner's Manual (Japanese)	
00451701	Owner's Manual (English)	
00349934	MODE LABEL	
12569173	BATTERY 006P 9V ALKALINE	

BIAS ADJUSTMENT



バイアス調整仕様

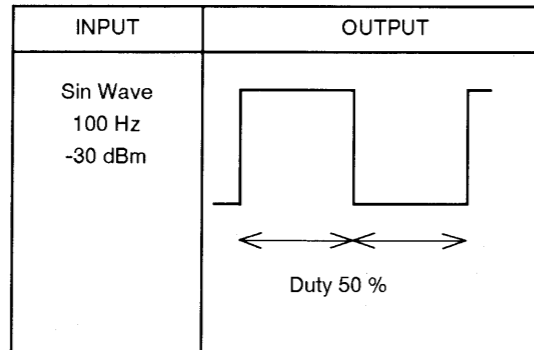

1. Feed the signal to INPUT of the PS-3.
2. Connect the scope to R8(resistor: TP-1 side).
3. Adjust RT1 on MAIN Board to obtain a waveform shown below.

- 1.INPUTにオーディオ発振器を接続します。
- 2.R8(抵抗:TP-1側)にオシロスコブを接続します。
- 3.下図の波形になるようにRT1を調節します。

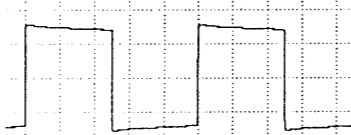

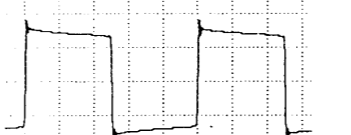

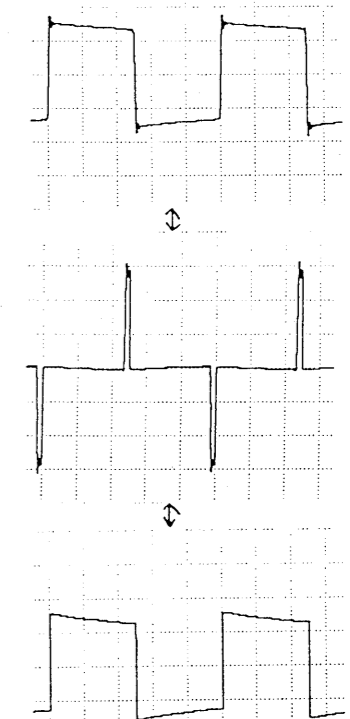

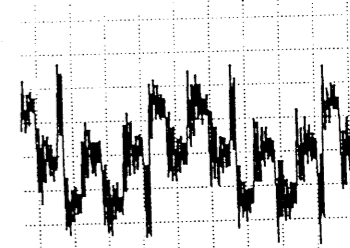
FINAL TEST SHEET/完成品検査仕様書

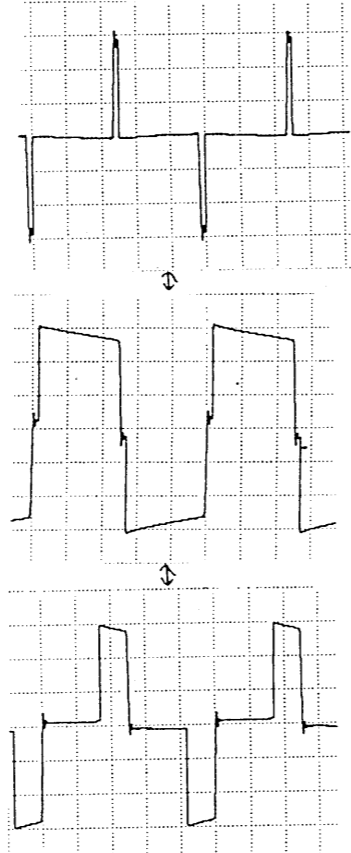

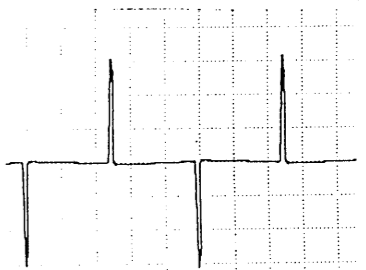
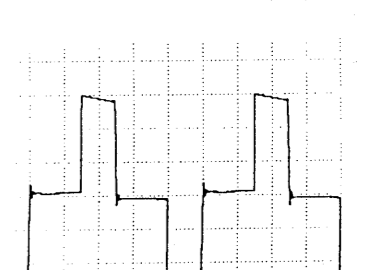
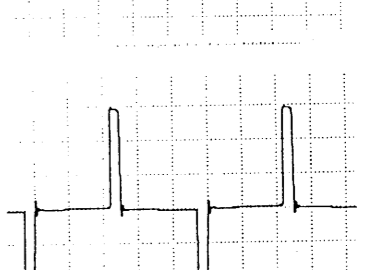

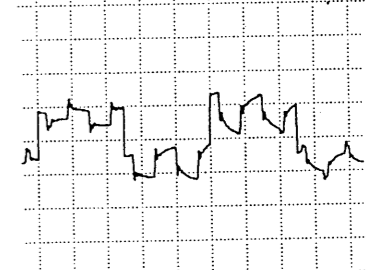
No.	Item/項目	VR Position of Tested Effector / 検査 EFFECTOR VR位置	Checkpoint
1	Power Check 電源チェック		Check that the current consumption is less than 70mA. Check that the EFFECT LED lights up. 消費電流が70mA以下であることを確認する。 エフェクトLEDが点灯することを確認する。
2	Normal Waveform Check ノーマル波形チェック Input/入力 200Hz 300mVp-p		Turn EFFECT off. Check that the waveform does not change even if turning the BALANCE knob. Check that the EFFECT LED turns off. EFFECT OFFにする。 バランス・ツマミを回しても波形が変化しないことを確認する。 エフェクトLEDが消灯することを確認する。  (RANGE:1mS/DIV, 0.1V/DIV)
3	EFFECT waveform Check エフェクト波形チェック Input/入力 200Hz 300mVp-p	 BALANCE:EFX PITCH-A: MIN PITCH-B: MIN MODE: 1	Check the output waveform. (For both OUTPUT A/B) 波形を確認する。(OUTPUT A/B両方)  (RANGE:1mS/DIV, 0.1V/DIV)

No.	Item/項目	VR Position of Tested Effector / 検査 EFFECTOR VR位置	Checkpoint
4	BALANCE VR Check バランスVRチェック Input/入力 200Hz 300mVp-p	 PITCH-A: MIN PITCH-B: MIN MODE: 1	Check that the waveform changes as shown below while turning the BALANCE knob. バランス・ツマミを回して波形の変化を確認する。  (RANGE: 1mS/DIV, 0.1V/DIV)
5	PITCH-A Knob Check PITCH-Aツマミチェック Input/入力 200Hz 300mVp-p	 BALANCE: CENTER PITCH-B: MIN MODE: 1	Check that the waveform changes as shown below while turning the PITCH-A (F. BACK) knob. PITCH-A(F. BACK)ツマミを回して波形の変化を確認する。  (RANGE: 1mS/DIV, 0.1V/DIV)

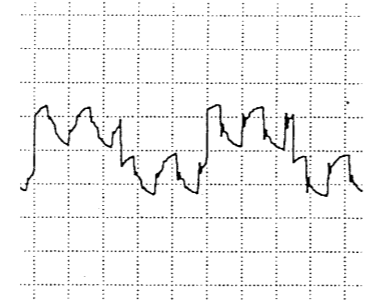
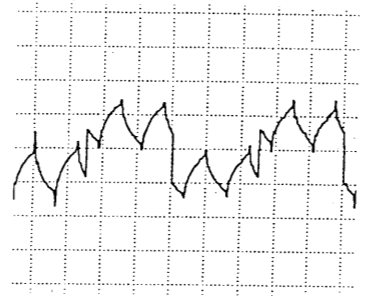
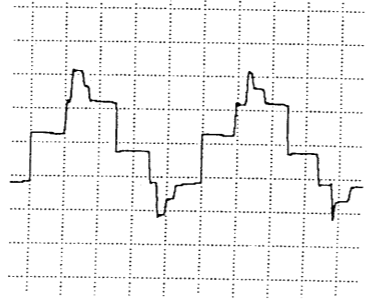
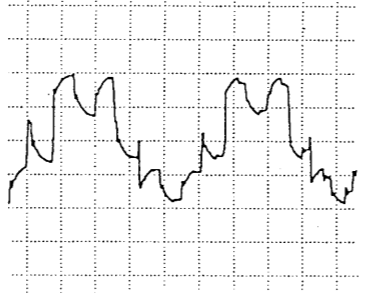
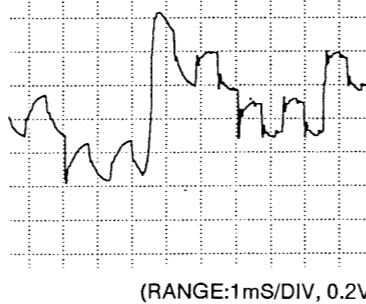
No.	Item/項目	VR Position of Tested Effector / 検査 EFFECTOR VR位置	Checkpoint
6	PITCH-B Knob Check PITCH-Bツマミチェック Input/入力 200Hz 300mVp-p	 BALANCE: CENTER PITCH-A: MIN MODE: 1	<p>Check that the waveform changes as shown below while turning the PITCH-B (D. TIME) knob. PITCH-B(D.TIME)ツマミを回して波形の変化を確認する。</p>  (RANGE: 1mS/DIV, 0.1V/DIV)

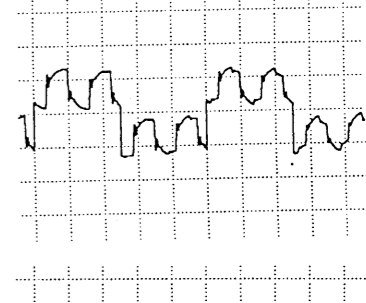
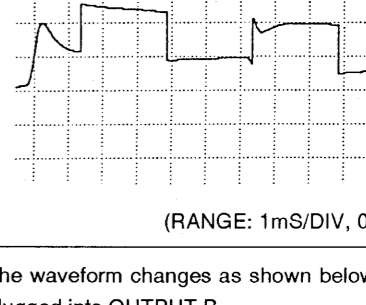
No.	Item/項目	VR Position of Tested Effector / 検査 EFFECTOR VR位置	Checkpoint
7	MODE Check MODEチェック Input/入力 200Hz 300mVp-p	 BALANCE: CENTER PITCH-A: MIN PITCH-B: MIN	<p>Waveform Example/参考波形 Check to see how the waveform changes. 波形の変化を確認する。</p> <p>MODE=1</p>  <p>MODE=2</p>  <p>MODE=3</p>  (RANGE:1mS/DIV, 0.1V/DIV)
		 BALANCE: CENTER PITCH-A: MIN PITCH-B: MAX	<p>MODE=4</p> 
			<p>MODE=5</p>  (RANGE:1mS/DIV, 0.2V/DIV)

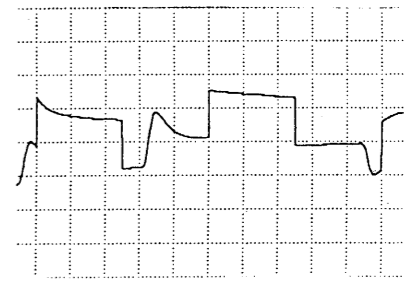
No.	Item/項目	VR Position of Tested Effector / 検査 EFFECTOR VR位置	Checkpoint
7	MODE Check MODEチェック Input/入力 200Hz 300mVp-p	 BALANCE: CENTER PITCH-A: MIN PITCH-B: MAX	MODE=6 
			MODE=7 
			MODE=8 
			MODE=9 
MODE=10  (RANGE:1mS/DIV, 0.2V/DIV)			

No.	Item/項目	VR Position of Tested Effector / 検査 EFFECTOR VR位置	Checkpoint
8	MODE Check MODEチェック EXP Pedal Check EXPペダルチェック Input/入力 200Hz 300mVp-p	 BALANCE: CENTER PITCH-A: MIN PITCH-B: MAX	MODE=11  MIN
			 MAX (RANGE: 1mS/DIV, 0.2V/DIV)
9	STEREO OUT Check STEREO OUT チェック Input/入力 200Hz 300mVp-p	 BALANCE: CENTER PITCH-A: MIN PITCH-B: MAX MODE: 10	Check that the waveform changes as shown below when a null jack is plugged into OUTPUT B. OUTPUT Bに空ジャックを入れて波形が変化するのを確認する。  (RANGE: 1mS/DIV, 0.2V/DIV)
			Less than 3% 3%以下 OUTPUT A only OUTPUT Aのみ
10	Distortion Check 歪率チェック Input/入力 100Hz -20dBm	 BALANCE: EFX PITCH-A: MIN PITCH-B: MIN MODE: 1	Less than 3% 3%以下 OUTPUT A only OUTPUT Aのみ
11	Noise Check ノイズチェック Input Short 入力ショート	 BALANCE: EFX PITCH-A: MIN PITCH-B: MIN MODE: 1	Less than -95dBm (JIS-A) Both OUTPUT A/B -95dBm以下(JIS-A) OUTPUT A/B両方

PS-3 BOARD
ASSY 70343134
(pcb 00348112)

NOTE

Replacement PS-3 Board Ass'y includes VR Board Ass'y.
補修用PS-3 Boardは、VR Boardを含みます。

CH-1 JACK BOARD
ASSY 7524452000
(pcb 2292768700)

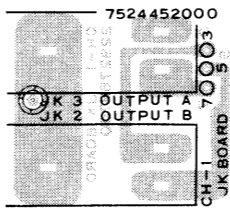

View from components side.

PS-3 BOARD

VR BOARD

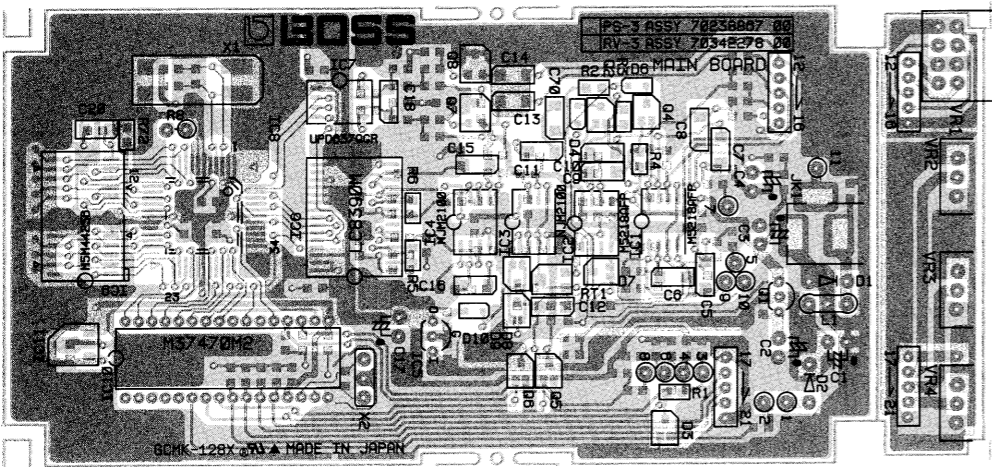

View from components side.

VR BOARD

PS-3 BOARD

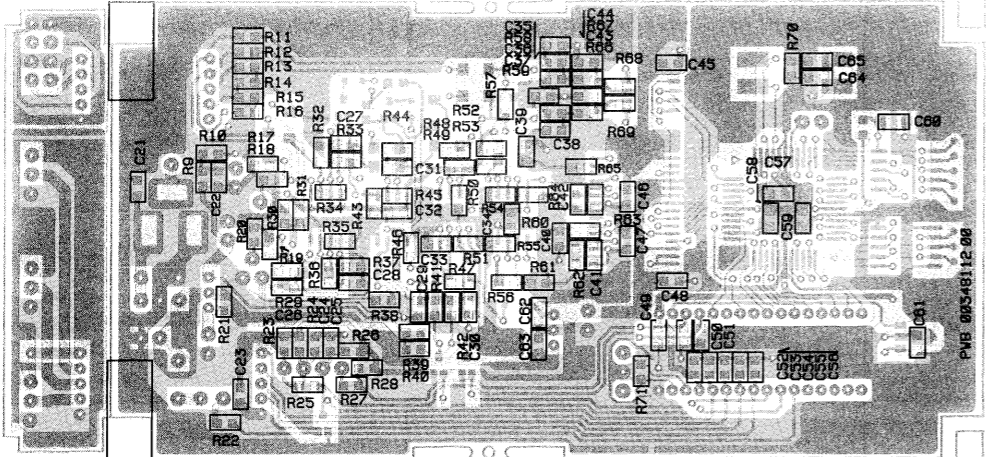

View from foil side.

CIRCUIT DIAGRAM/回路図

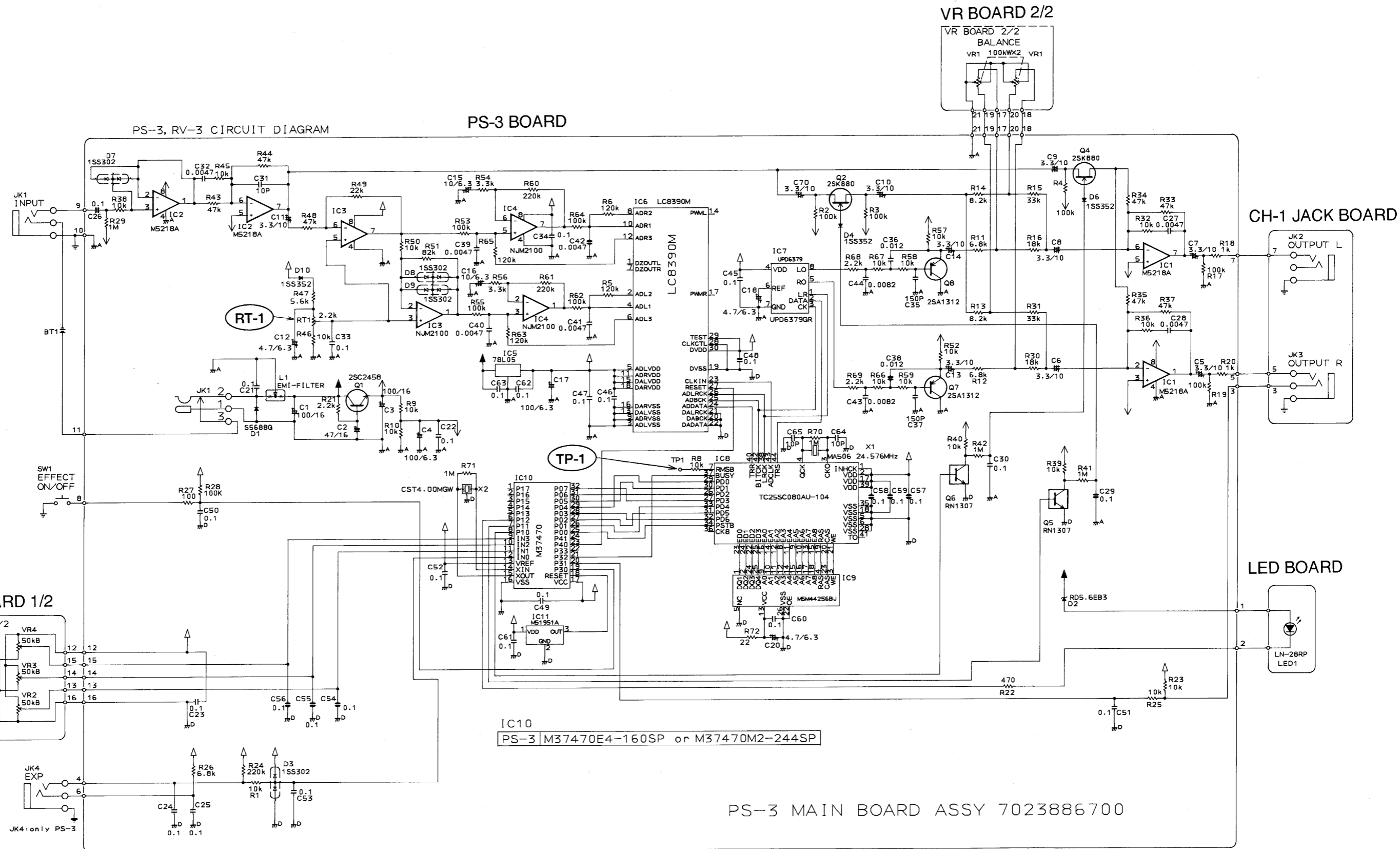

IC10
 PS-3 M37470E4-160SP or M37470M2-244SP

PS-3 MAIN BOARD ASSY 7023886700

A
B
C
D
E
F
G
H
I
J
K
L
M
N
O
P
Q
R
S
T
U
V
W
X
Y
Z